



GE HealthCare

Bone & Metabolic Health

# Lunar iDXA™ from GE HealthCare



Exceptional Precision  
and Accuracy

[gehealthcare.com/bmh](http://gehealthcare.com/bmh)

# Advanced DXA technology for bone and metabolic health assessment

Lunar iDXA offers excellent image resolution and clarity with exacting precision, designed to provide you a high degree of clinical confidence across all body types for bone health and body composition.



## Advanced Insights into Bone and Metabolic Health

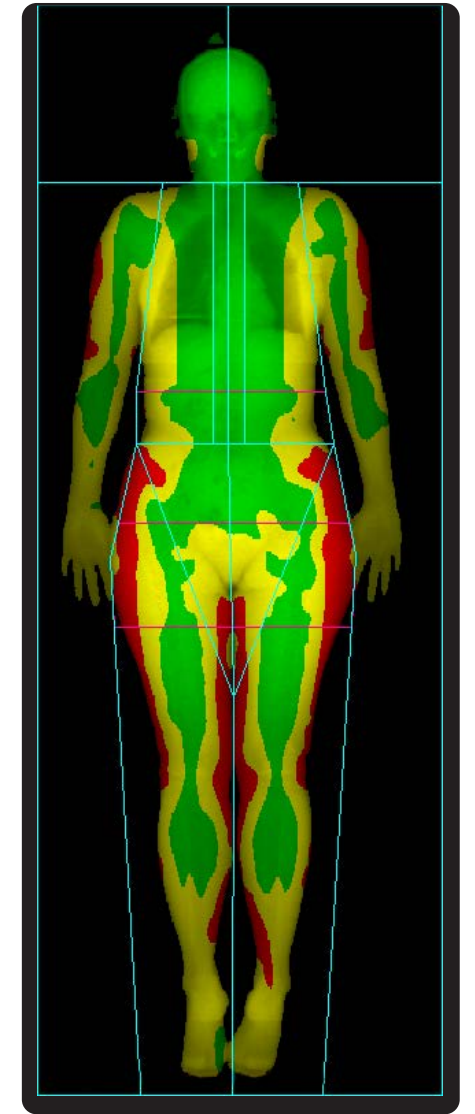
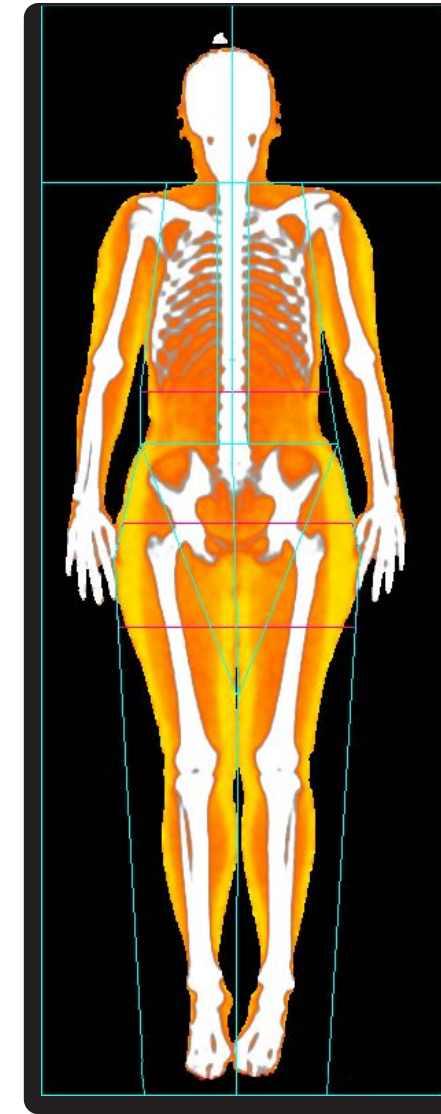
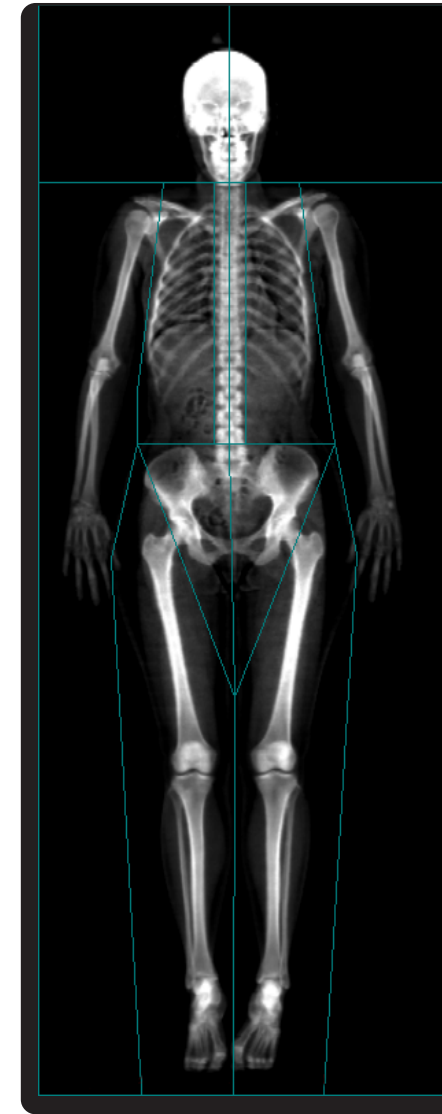

### See More. Know More.

Research-grade analysis helps you manage patients with confidence.

In your search for answers to a patient's health concerns, information is everything. And with Lunar iDXA, GE HealthCare offers our most advanced system to provide the data and images you need. Whether you're assessing bone density, fracture risk, metabolic health, pediatric development or sarcopenia, Lunar iDXA gives you a clear view inside the body.



# Lunar iDXA for Bone Health

## Exceptional clarity.

One in four women over the age of 50 will suffer a vertebral fracture in her remaining lifetime, with severe impact on quality of life.<sup>1</sup>

Its vertebral assessment is comparable to radiographs in identifying and classifying deformities concerning etiology, grade, and shape,<sup>1</sup> while using a lower dose of radiation.

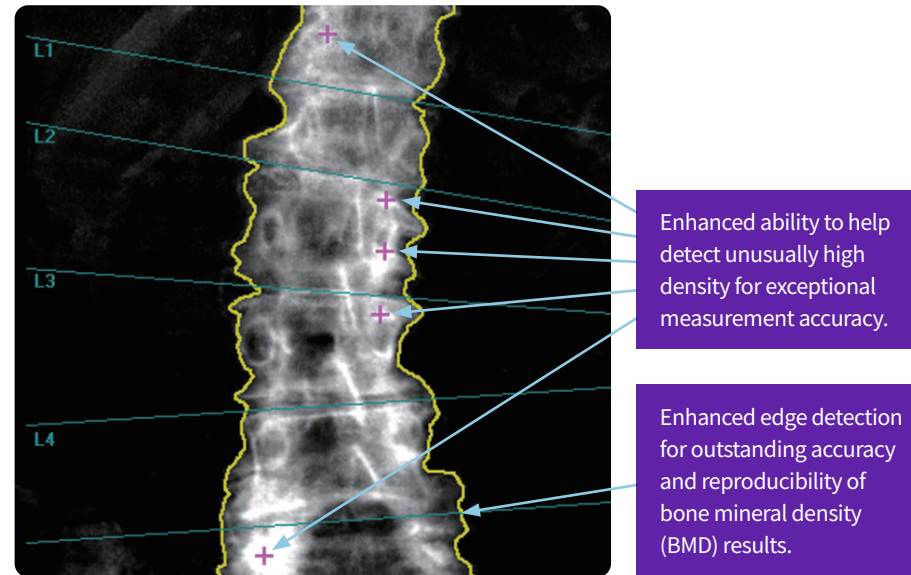

## High-resolution images bring anatomy into focus.

Lunar iDXA delivers crisp, high resolution images that clearly render the end plates on spine images and identify intervertebral spaces. See proximal femur details and visualize cortical thickness.

Lunar iDXA helps you detect vertebral deformations and estimate vertebral heights.

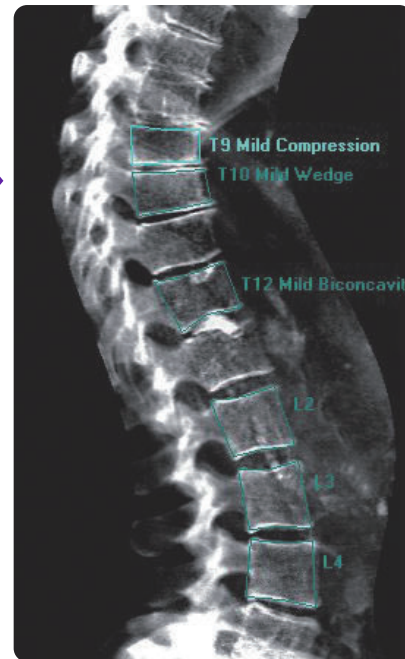

See vertebral bodies clearly with dual-energy soft tissue subtraction.

## Performance comparison of DXA beam types

	Pencil Beam	Narrow Fan Beam	Wide Fan Beam
Scan time	Long	Short	Short
Bone height measured	No	Yes	No
Magnification effects	No	No	Yes
Off-center distortions	No	No	Yes
Scattered radiation	Lowest	Low	High

## Detect small changes nearly twice as fast.\*

Osteoporosis treatment and other clinical interventions require time to monitor. Lunar iDXA helps with exceptional precision, due to its direct-to-digital detector plus staggered array and narrow-angle fan beam technology with Multi-View Image Reconstruction (MVIR). This prevents magnification error that is present in competitive wide-angle fan beam systems<sup>2</sup>

What's all this precision worth to you? It enables you to detect statistically significant changes sooner, which can help motivate patient compliance, guide treatment decisions and reduce sample size required for clinical trials.

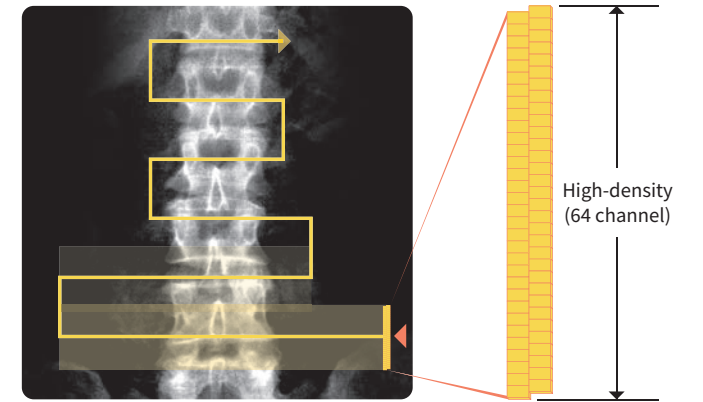

Direct-to-digital detector plus staggered array enhance precision and create high-resolution images.

\*In this example, analysis shows that precision with Lunar iDXA allows clinicians to detect true metabolic change as early as 5.8 months, compared with 10.8 months for competitive equipment (95% confidence).<sup>3,4</sup>

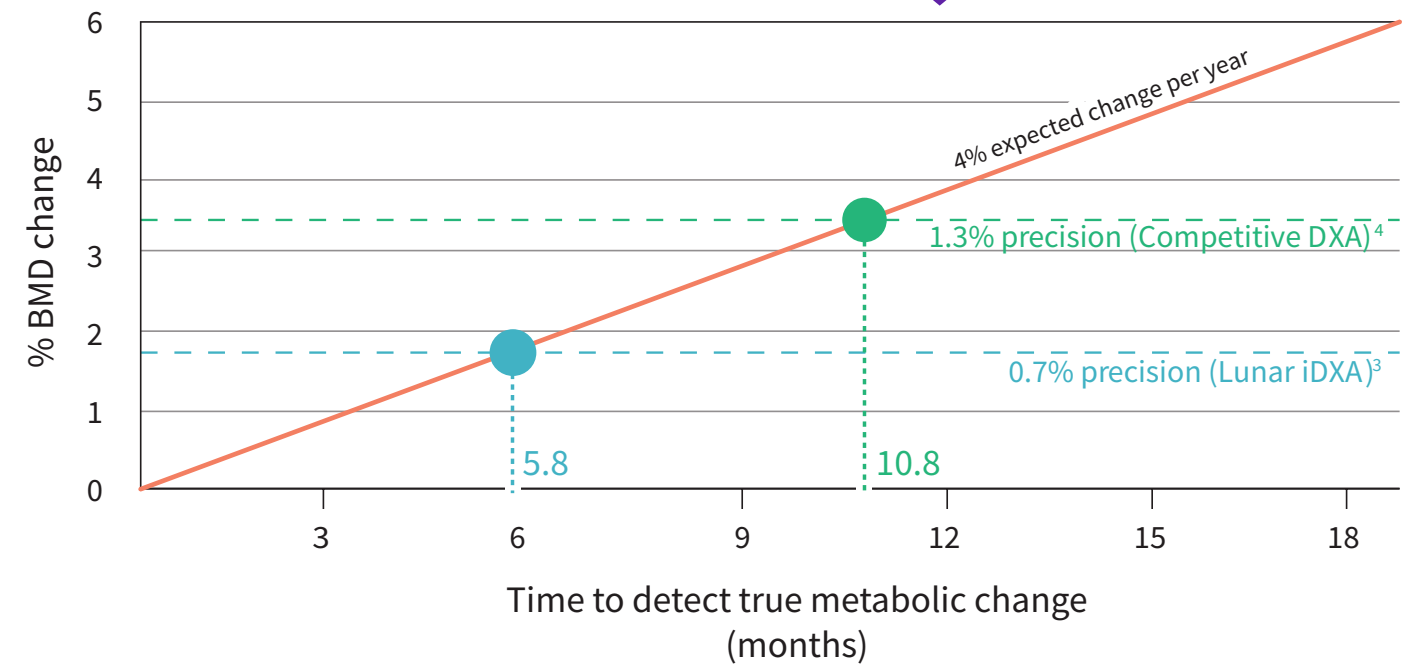

# Lunar iDXA for Metabolic Health

## Visualization Tools

Advanced visualization tools help patients understand impact of diet, lifestyle and exercise on their health and athletic performance. Utilize color coding for an effective visualization of lean, fat and bone distribution from a total body scan. Our color mapping tool enables you to set custom thresholds for viewing fat and lean mass.

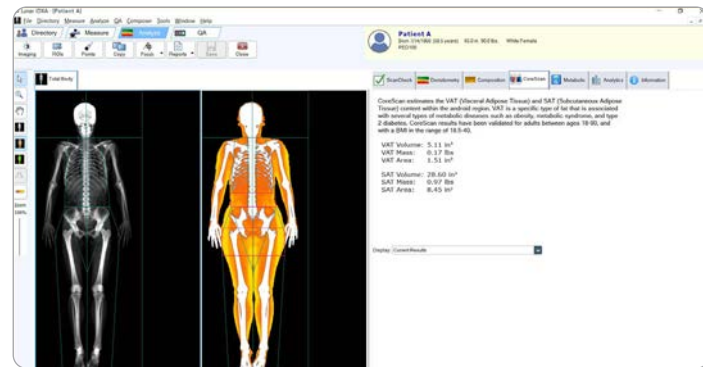

Newly Available: VAT Area and SAT Results

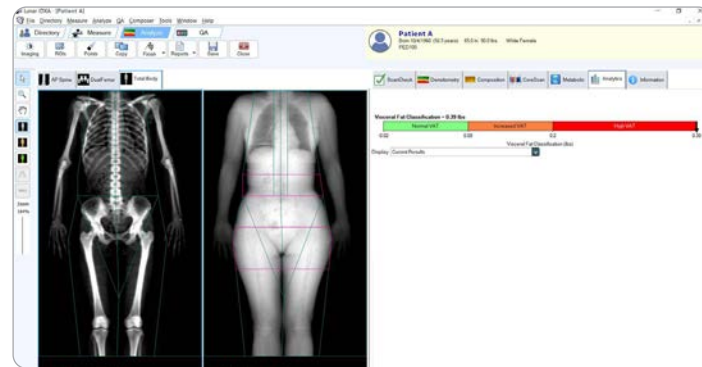

Body Composition Insights using VAT Customizable Thresholds

## Advanced Metabolic Insights

- Total Body Composition
- RMR, RSMI, BMC, fat and lean trending
- Sarcopenia
- Custom Reference Population
- Option to Integrate Hydration Levels from BIA/BIS (TBW, ECW, ICW) to have 5 compartment models (LM, FM, BMC, ECW, ICW) and more

Higher precision enables best estimate of Appendicular Lean Mass (ALM) for effective assessment of sarcopenia.



# Fully Customizable Reports

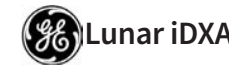

GE Healthcare  
3030 Ohmeda Drive  
Madison, WI 53718  
Phone: 608 221-1551

Bone Densitometry Report: Monday, February 18, 2013

Referring Physician: Dr. Phlox

**PATIENT:**

Name: ##### Birth Date: ##### Height: #####  
 Patient ID: ##### Sex: ##### Weight: #####  
 Indications: Low Calcium Intake Fractures: ##### Treatments: #####

**ASSESSMENT:**

The BMD measured at Femur Total Left is 0.928 g/cm<sup>2</sup> with a T-score of -0.6. Bone density is up to 10% below young normal. This patient is considered normal according to World Health Organization (WHO) criteria. With a Z-score of -0.1, this patient's BMD is within normal limits for their age and sex, even though bone loss may have occurred.

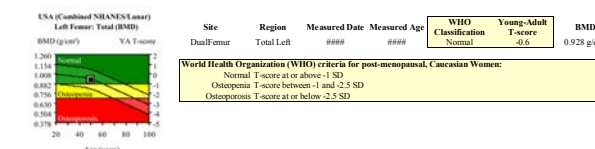

**RECOMMENDATION:**

All patients should ensure an adequate intake of dietary calcium and vitamin D. The NOF recommends adults under age 50 need 1,000 mg of calcium and 400-800 IU of vitamin D daily. Adults 50 and over need 1,200 mg of calcium and 800-1,000 IU of vitamin D daily. Effective therapies for the prevention of osteoporosis include bisphosphonates (Fosamax and Actonel) and Evista. Hormone therapy may be an option based on review of risks and benefits of treatment.

**FOLLOW-UP:**

People with diagnosed cases of osteoporosis or at high risk for fracture should have regular bone mineral density tests. For patients eligible for Medicare, routine testing is allowed once every 2 years. The testing frequency can be increased to one year for patients who have rapidly progressing disease, those who are receiving or discontinuing medical therapy to restore bone mass, or have additional risk factors.

Based on these results, a follow-up exam is recommended in ####

GE Healthcare  
3030 Ohmeda Drive, Madison, WI 53718  
Phone: 608 221-1551

Patient: ##### Referring Physician: Dr. Phlox  
 Birth Date: ##### Patient ID: #####  
 Height: ##### Weight: ##### Measured: ##### (10.00)  
 Sex: ##### Ethnicity: ##### Analyzed: ##### (15.00)

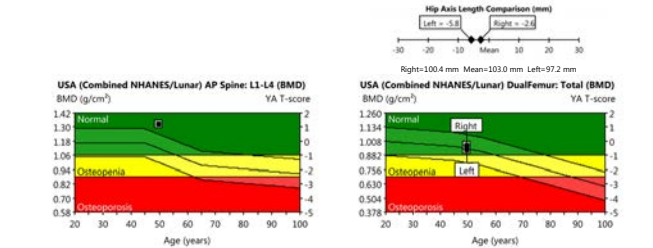
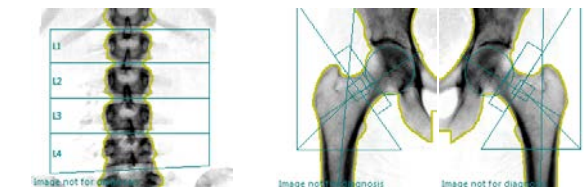

Region	BMD (g/cm <sup>2</sup> )	Young-Adult T-score	Age-Matched Z-score	WHO Classification
AP Spine L1-L4	1.325	1.2	1.7	Normal
Dual Femur Total Left	0.928	-0.6	-0.1	Normal
Total Right	0.970	-0.3	0.2	Normal
Total Mean	0.949	-0.5	0.1	Normal
Total Diff	0.042	0.3	0.3	N/A

Fully customizable reports can be made as concise or as detailed as needed.

OneScan performs spine and dual femur BMD measurements in a single acquisition without repositioning<sup>6</sup> Results print in a one-page report.

# A Few of our Newest Applications

## A wide breadth of applications and features

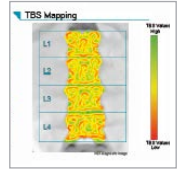

**Trabecular Bone Score – Integrated TBS**  
Provides TBS score based on assessment of trabecular region of bone, including FRAX-adjusted TBS. Includes TBS license. Complimentary 60-day TBS software trial program available for new TBS customers.

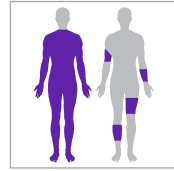

**Sports Athletics Package**  
Includes TBLH (Total Body Less Head) for Adults and Smaller Body Comp – ROI to easily scan and report on specific Regions of Interest. Facilitates study of localized changes in body composition.

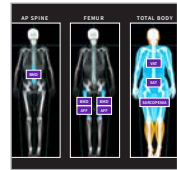

**DXAVision™**  
Provides one unified workflow and comprehensive reporting for BMD, AFF, VAT and SAT.<sup>6</sup> Designed to improve operator efficiency with a scan time up to 40% faster.<sup>7</sup> Includes Total Body and Smaller Body (ROI) Composition, Total Body Less Head (TBLH) and Neck-to-Knee for Adults.

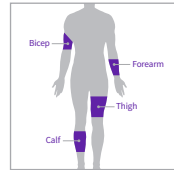

**Smaller Body Composition (Regions of Interest)<sup>9</sup>**  
Monitor and report on Regions of Interest (ROI) including upper arm, lower arm, upper leg and lower leg, to study changes in body composition in these regions.

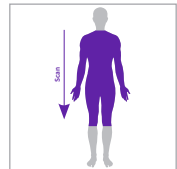

**Neck-to-Knee for Adults<sup>8</sup>**  
Performs a faster scan by omitting head and lower legs, providing an estimate of total body composition.

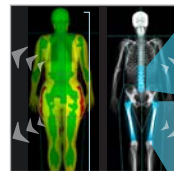

**Advanced Analytics**  
Provides deep BMD and Body Composition insights with custom equations, metrics and ratios based on 200+ DXA bone and body composition parameters. User-defined classification thresholds, trending and reporting.

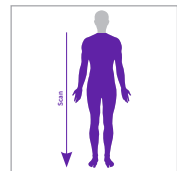

**Total Body Less Head (TBLH) for Adults<sup>9</sup>**  
Including the skull can mask changes occurring in other areas of the skeleton; this tool automatically performs a scan from the neck down. Can also get TBLH results for scans with the head included.



**Customizable Thresholds (AFF and VAT)<sup>10,11,12</sup>**  
Enables setting of custom thresholds to search for correlations: between "beaking" and the probability of AFF, and between VAT and the probability of metabolic disorders.



**CoreScan with VAT and SAT Results**  
CoreScan estimates Visceral and Subcutaneous Adipose Tissue (VAT and SAT) mass, volume and area within the android region. Values can be displayed in user-defined statistical formats and trends.



**Composer Reporting**  
Provides default style sheets, which can be edited using an intuitive WYSIWYG interface to quickly produce customized reports and templates.

# Advanced Analytics Power Deeper Insights

## Create your own custom equations and ratios

Analyze data within your DXA: create custom ratios, make predictions, and pin metrics pinned on the built-in dashboard to track changes over time.

## More than 200 Bone and Body Composition Parameters for Analysis.

$$\text{Sample Metric} = \text{VAT Mass} / \text{Total Fat Mass}$$

### Body Composition Analytics

- DXA Parameters**
  - BMC
  - Fat Free Mass
  - Fat Mass
  - Lean Mass
  - Region %Fat
  - Tissue %Fat
  - Tissue Mass
  - Total Mass
- Regions**
  - Left Arm
  - Right Arm
  - Android
  - Gynoid
  - VAT
  - SAT
  - Total Body
  - TBLH
  - much more

Composition

- DXA Parameters**
  - Area
  - BMC
  - BMD
  - BMD %AM
  - BMD %YA
  - BMD T-Score
  - BMD Z-Score
- Regions**
  - Left Arm
  - Right Arm
  - Android
  - Gynoid
  - VAT
  - SAT
  - Total Body
  - TBLH
  - much more

Densitometry

### Bone Analytics – Various Skeletal Sites

- Regions**
  - L1
  - L2
  - L3
  - L4
  - L1-L2
  - L1-L4
  - etc.
- DXA Parameters**
  - Area
  - BMD
  - BMC
  - BMD %AM
  - BMD %YA
  - BMD T-Score
  - BMD Z-Score

AP Spine

- Regions**
  - Neck
  - Trochanter
  - Shaft
  - Total
  - etc.
- DXA Parameters**
  - AFF Beaking Index
  - Area
  - BMD
  - BMC
  - BMD %AM
  - BMD %YA
  - BMD T-Score
  - BMD Z-Score

Femur

Note: Some parameters may require purchase of additional features.

Custom Regions of Interest (ROI) can also be used with Advanced Analytics feature. Metrics and trending can be retrospectively performed on past data as well.



# Multi-User Database with a Secure Platform

Acquire and save images from multiple GE HealthCare densitometers to a common database.

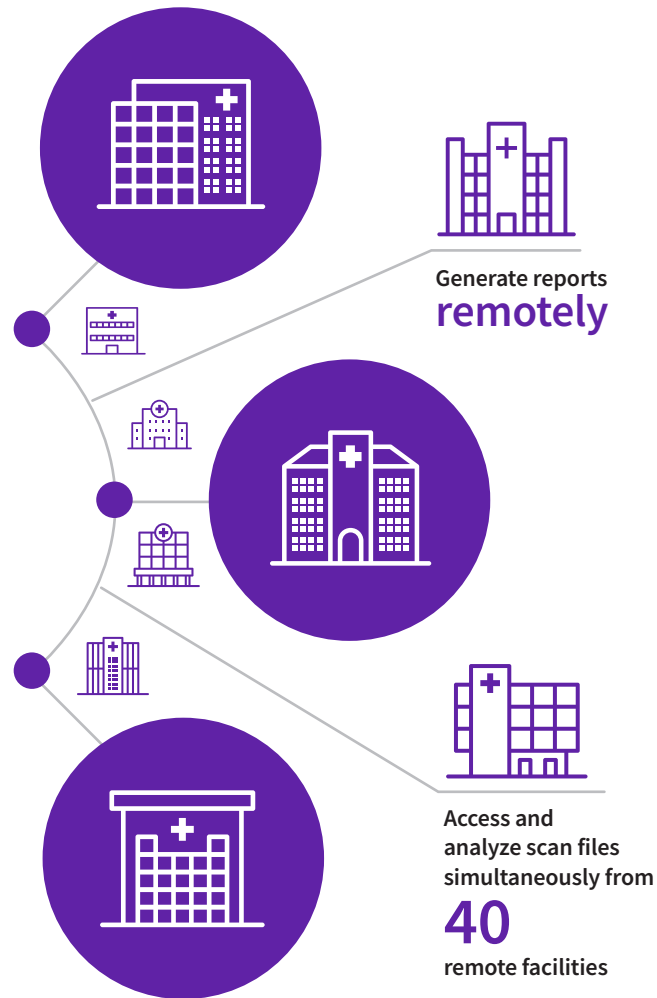

Windows® 10 Compatibility

## Advanced security features protect your data.

Security Feature	Provided Benefit
IPv6 for DICOM and HL7	Communication protocol integrating IPSec for better security during data exchange
FIPS 140-2 Encryption	Federally compliant encryption standard that protects patient exam files using 256-bit encryption
Audit Trails	Logs information related to: <ul style="list-style-type: none"> <li>• Software configuration and user access changes, destination IP addresses</li> <li>• Database events including authentication, patient modification/deletion</li> <li>• Events supported by the DICOM Audit Trail Profile</li> </ul>
TLS for DICOM®	Provides security at the transport layer of a DICOM transaction by using encryption and node authentication. TLS is an updated, more secure, version of the SSL protocol.

# Advanced Technology. Incredible Results.

Lunar iDXA uses innovative photon-counting detector technology that provides near-radiographic image quality.

These detectors utilize solid-state Cadmium Telluride (CdTe) crystals to absorb the x-ray energy, which immediately release electrons from their atoms (i.e. direct conversion). An applied voltages pushes the electrons out of the CdTe crystal, effectively creating a current pulse with a magnitude proportional to the x-ray energy. The signal is boosted and finally identified as low or high energy.

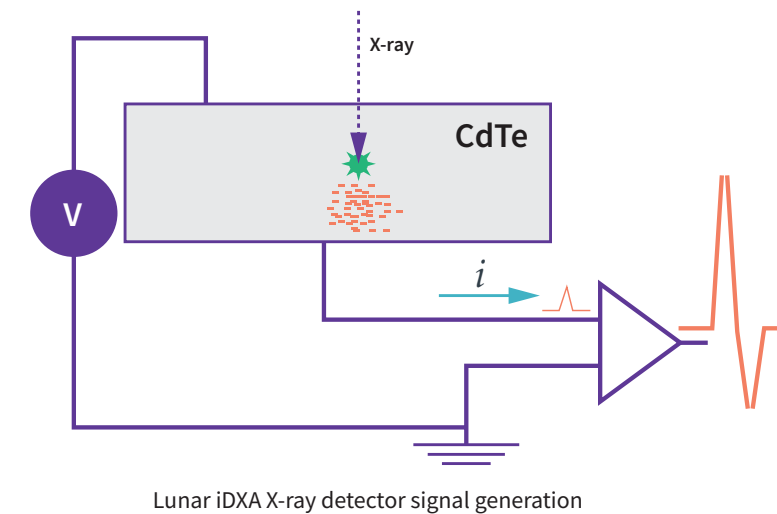

CdTe Photon Counting detector for high resolution and efficiency

GE HealthCare's Performa X-ray Tube is designed from the ground up to deliver the ultra-stable output needed for high precision, image clarity, and long-term reliability.

**Patented Narrow Fan Beam Scan**  
Combining the features of pencil beams and wide fan beams, Narrow Fan Beam technology offers a short scan time with reduced magnification error (inherent to wide-angle fan beam scans).<sup>13</sup>

**Low-Dose Photon Counting Technology**  
Dose-efficient photon counting detector technology lowers dosage to the patient.<sup>13</sup>

**Innovative SmartScan™**  
Our SmartScan technology reduces scan time and X-ray dosage by identifying bone regions after each transverse sweep and estimating where to begin scanning on the subsequent sweep.<sup>14</sup>

**K-edge Filter**  
An exceptional "K-edge filter" that creates a dual energy beam and absorbs the X-rays in the middle energy range and protects the patient against unnecessary exposure.

**Multi-View Image Reconstruction (MVIR)**  
By performing multiple transverse sweeps across the site of interest, MVIR accurately determines bone-height above the tabletop, minimizes magnification errors and provides excellent precision and accuracy.

**Low Scattered Radiation**  
Narrow-fan beam technology results in low scatter radiation in comparison to wide-angle fan beam systems.<sup>15</sup>

Clinical Application

	<span style="color: green;">✔</span> Standard <span style="color: blue;">●</span> Optional <span style="color: grey;">✘</span> Not Available	Lunar iDXA with Pro SW Package	Lunar iDXA with Advance SW Package
AP Spine		✔	✔
Femur/Dual Femur		✔	✔
Forearm/Non-seated Forearm		✔	✔
Total Body BMD		✔	✔
FRAX® Fracture Risk Tool		✔	✔
DVO Fracture Risk Tool <sup>16</sup>		✔	✔
Multi-User Database (1-3)		✔	✔
ScanCheck		✔	✔
Practice Management		✔	✔
Composer		✔	✔
OneScan		✔	✔
OneVision		✔	✔
Pediatric – AP Spine		✔	✔
Pediatric – Femur		✔	✔
Pediatric – TB (Birth to 20 YO)		✔	✔
Total Body Comp		✔	✔
CoreScan		✔	✔
Quick View		✔	✔
DVA (Includes: LVA, APVA, Lateral BMD)		●	✔
Advanced Body Comp <sup>17</sup>		●	✔
Orthopedic Hip		●	✔
Advanced Hip Assessment		●	✔
Orthopedic Knee		●	✔
Hand		●	✔
Multi-User Database (Up to 40)		●	✔
Spine Geometry		●	✔
Atypical Femur Fracture		●	●
Sarcopenia		●	●
Small Animal		●	●

New v18 Applications

Integrated TBS	●	●
DXAVision™	●	●
Sports Athletics Package	●	●
Advanced Analytics Full	●	●
Advanced Analytics Bone	●	●
Advanced Analytics Body Comp	●	●

# Specifications

## Scanner dimensions:

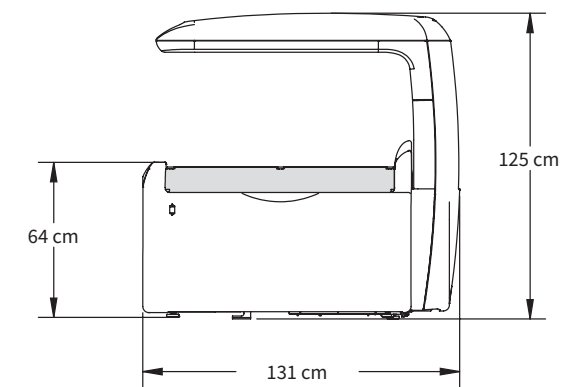
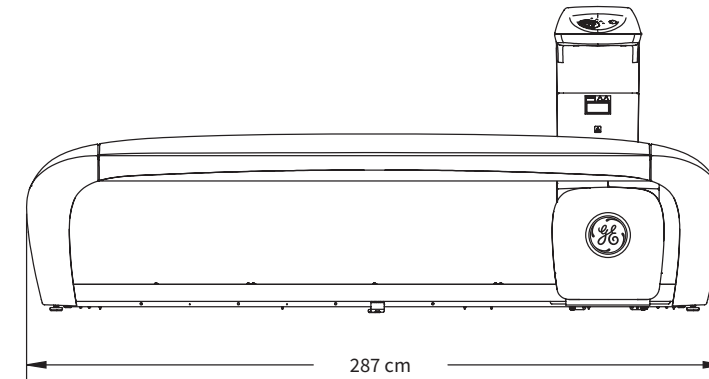

## Minimum room dimensions<sup>18</sup>:

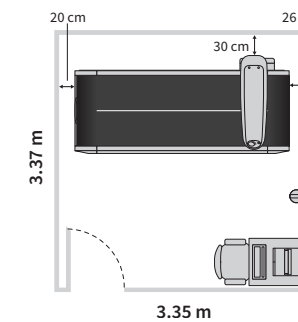

The Lunar iDXA is designed to have minimal impact in both installation requirements and operating space. The Lunar iDXA is shown in a 3.35 m x 3.37 m exam room with the included workstation. No operator shielding or special site preparation beyond a dedicated 100-127/200-240 VAC duplex outlet is usually required.<sup>19</sup> Place outlet near the desired location of the operator's console.

## Scanner table specifications:

Scanner size ..... 2.87 m x 1.31 m x 1.25 m  
 Scanner weight ..... 353 kg  
 Patient table top height ..... 64 cm  
 Maximum patient weight supported ..... 227 kg  
 Drive system ..... stepper motor with reinforced drive belts  
 Active scan area ..... 198 cm x 66 cm  
 Start position indicator ..... cross laser light (class II, <1 mW power)  
 Pad ..... washable patient mat, includes paper roll dispenser  
 Attenuation of patient support table ..... <1.2 mm AL  
 Communication cable ..... Ethernet  
 Scanner leakage current ..... meets IEC 60601-1 safety standard

## Connectivity:

- Teledensitometry<sup>20</sup>
- DICOM® interface
- HL7 interface
- SQL Server

## Detector specifications:

Detector ..... high-definition, direct-digital detector

## Computer specifications:

Processor ..... Intel® Core™ i3  
 Operating System ..... Windows® 10 IoT 2021 LTSC  
 Memory ..... RAM 8 GB  
 Storage ..... 1 TB NVMe SSD  
 Optical Drive ..... DVD-RW SATA  
 Monitor ..... 24" SVGA (min resolution 1920 x 1080 32-bit color)  
 Archive Drive (optional) ..... 1 TB USB  
 Document viewing ..... Adobe® Reader® DC  
 Browser ..... Microsoft Edge  
 Connector ..... RS-232 Serial Port  
 Printer ..... Windows®-compatible

## Environmental specifications:

Power ..... 100-127 VAC 50/60Hz 20A dedicated circuit  
 ..... 200-240 VAC 50/60Hz 10A dedicated circuit  
 Consumption ..... idling 40VA, scanning 525VA  
 Distortion ..... sinusoidal waveform, less than 5% THD  
 Humidity ..... 20%-80% non-condensing  
 Room temperature ..... 18°C-27°C  
 Scanner heat output ..... idling 150 BTU/hr, scanning 1800 BTU/hr  
 Console heat output ..... approx. 200 BTU/hr with 24" monitor  
 Ventilation ..... all cooling vents must remain unblocked  
 Dust, fumes, debris ..... install system in clean, ventilated area  
 Altitude ..... tested up to 4,000 m

## References:

1. Armbrecht G, Felsenberg D. Diagnostic of vertebral deformities: Comparison of VFA (GE iDXA) to conventional radiographs. ASBMR 2009.
2. IDXA precision (Total Femur BMD). Ergun DL, Wacker WK, Zhou QQ, et al. Performance of the Lunar iDXA. Presented at the 17th International.
3. IDXA precision (Total Femur BMD). Ergun DL, Wacker WK, Zhou QQ, et al. Performance of the Lunar iDXA. Presented at the 17th International Bone Densitometry Workshop, Kyoto, Japan, November 2006.
4. Hologic Delphi precision (Total Left Hip BMD). Shepherd JA, Fan B, Lu Y, et al. Comparison of BMD precision for Prodigy and Delphi spine and femur scans. Osteoporos Int. 2006;17:1303-1308.
5. S.M. Hunt et al, "Changing Bone Densitometers in Clinical Practice: Effect on Precision Error", Presented at the American Society for Bone and Mineral Research Annual Meeting, September 23-27, 2005, Nashville, TN, USA.
6. Requires purchase of AFF application and Corescan (for VAT and SAT) application.
7. Data on file with GE Healthcare, April 2019.
8. Requires DXAVision.
9. Requires DXAVision or Sports Athletics Package.
10. Requires Advance Analytics.
11. Customizable Threshold for AFF requires AFF Application.
12. Customizable Threshold for VAT requires CoreScan application.
13. Data on file with GE Healthcare DOC2394474.
14. Data on file with GE Healthcare, March 2019.
15. Data on file with GE Healthcare, January 2017.
16. German speaking countries only.
17. Bone-Lean-Tissue Color Coding, Metabolic Results (ICW, ECW, TBW), Resting Metabolic Rate, Composer Style Sheets – Body Sports Medicine Segmental, Body Patient Weight Loss.
18. A small room kit with isolation transformer may be required. Please refer to local regulations.
19. Consult and follow local X-ray regulations.
20. Additional hardware may be required for fax capabilities.