



GE HealthCare

Bone & Metabolic Health

Prodigy™ from GE HealthCare



Performance and reliability
with one of the largest
installed base DXA systems
in the world

gehealthcare.com/bmh

Prodigy

High performance, efficient and reliable DXA system with the versatility to offer bone density test and body composition analysis. Prodigy systems provide the option to scale up to a wide-range of clinical applications.



Full and compact size DXA systems provide flexibility to meet the unique space requirements of your facility.

Available in Full or Compact sizes.



Your practice demands dependable dual-energy X-ray absorptiometry (DXA) assessment, and Prodigy delivers with exceptional precision and low-dose radiation. You can depend on Prodigy to provide precise data on bone and soft tissue composition, including bone-mineral density (BMD), lean- and fat-tissue mass, and percentage of fat. At the same time, Prodigy helps streamline your patient care and practice workflow.

Prodigy software packages – Customized to suit your needs

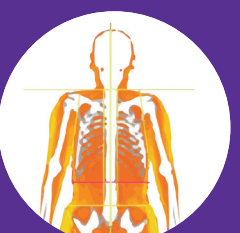
<p>Prodigy Primo</p>  <p>Package includes:</p> <ul style="list-style-type: none"> • Basic Skeletal Assessment • Basic Body Composition 	<p>Prodigy Pro</p>  <p>Package includes:</p> <ul style="list-style-type: none"> • Essential Skeletal Assessment • Essential Body Composition Assessment • Pediatric Measurements 	<p>Prodigy Advance</p>  <p>Package includes:</p> <ul style="list-style-type: none"> • Advanced Skeletal Assessment • Advanced Body Composition Assessment • Pediatric Measurements • Multi-User Database
--	---	--



Solid performance makes Prodigy chosen worldwide



Prodigy is our proven and dependable DXA product with a large global installed base across 120+ countries.

Clinicians, Researchers and Practitioners have trusted the Prodigy DXA system for more than 20 years making it one of the largest selling DXA systems in the world.

Prodigy with enCORE v18 software enables you to meet ISCD testing guidelines

ISCD indications for Bone Mineral Density (BMD) testing:

- Women 65 and older
- Men 70 and older
- Post-menopausal women with a risk factor:
 - Low body weight
 - Prior fracture
 - High risk medication use
- Adults taking medications associated with low bone mass or bone loss
- Adults with disease or condition associated with low bone mass or bone loss

ISCD guidelines for BMD testing available at ISCD.org



Prodigy for Bone Health

Prodigy's reliable design and robust technology platform supports a comprehensive portfolio of clinical applications for bone health.

- Bone Mineral Density
- FRAX
- Trabecular Bone Score (TBS)
- DVA (includes LVA, APVA and Lateral BMD)
- Atypical Femur Fracture and more

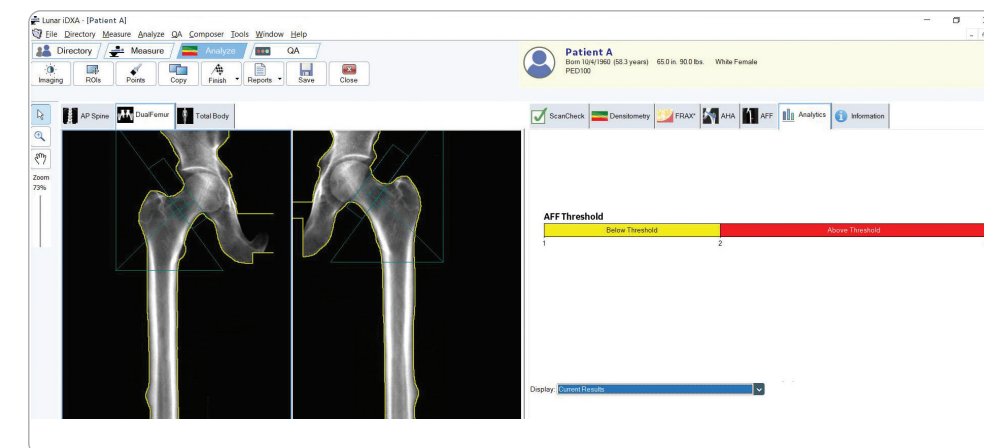

BMD Insights using AFF User Customizable Threshold

Prodigy for Metabolic Health

Prodigy offers a wide range of clinical applications for metabolic health needs.

- Total Body Composition
- CoreScan
- Sarcopenia
- Fat Color Coding
- Custom Reference Population
- Option to Integrate Hydration Levels from BIA/BIS (TBW, ECW, ICW) to have 5 compartment models (LM, FM, BMC, ECW, ICW) and more

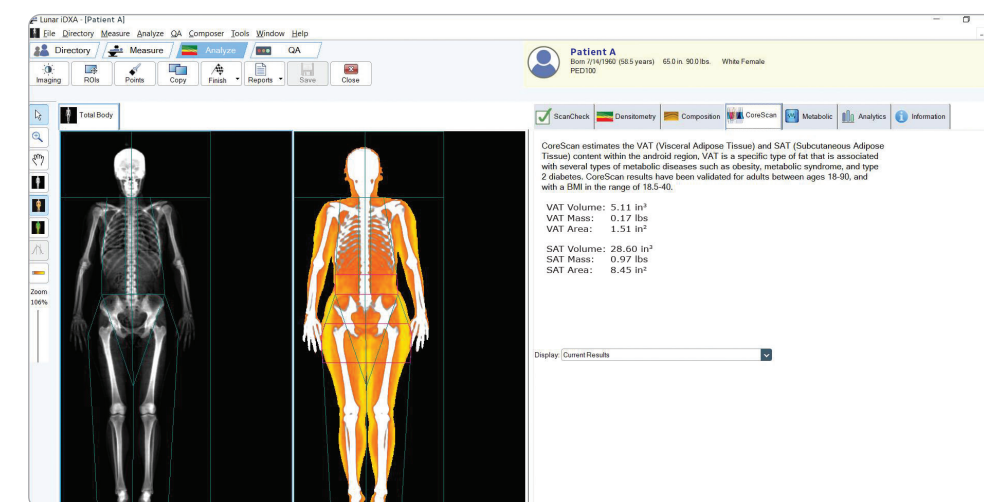

Newly Available: VAT Area and SAT Results

A Few of our Newest Applications

A wide breadth of applications and features

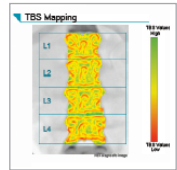

Trabecular Bone Score – Integrated TBS¹
Provides TBS score based on assessment of trabecular region of bone, including FRAX-adjusted TBS. Includes TBS license. Complimentary 60-day TBS software trial program available for new TBS customers.

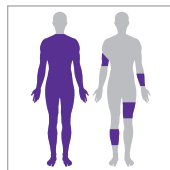

Sports Athletics Package
Includes TBLH (Total Body Less Head) for Adults and Smaller Body Comp – ROI to easily scan and report on specific Regions of Interest. Facilitates study of localized changes in body composition.

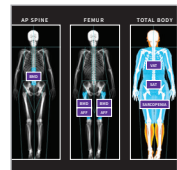

DXAVision™
Provides one unified workflow and comprehensive reporting for BMD, AFF, VAT and SAT.² Designed to improve operator efficiency with a scan time up to 40% faster.³ Includes Total Body and Smaller Body (ROI) Composition, Total Body Less Head (TBLH) and Neck-to-Knee for Adults.

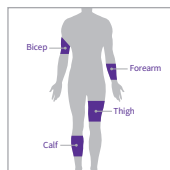

Smaller Body Composition (Regions of Interest)⁵
Monitor and report on Regions of Interest (ROI) including upper arm, lower arm, upper leg and lower leg, to study changes in body composition in these regions.

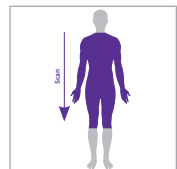

Neck-to-Knee for Adults⁴
Performs a faster scan by omitting head and lower legs, providing an estimate of total body composition.

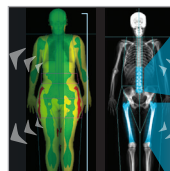

Advanced Analytics
Provides deep BMD and Body Composition insights with custom equations, metrics and ratios based on 200+ DXA bone and body composition parameters. User-defined classification thresholds, trending and reporting.

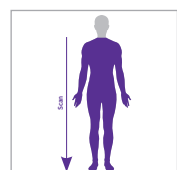

Total Body Less Head (TBLH) for Adults⁵
Including the skull can mask changes occurring in other areas of the skeleton; this tool automatically performs a scan from the neck down. Can also get TBLH results for scans with the head included.

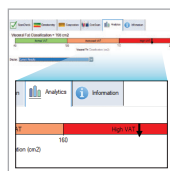

Customizable Thresholds (AFF and VAT)^{6,7,8}
Enables setting of custom thresholds to search for correlations: between "beaking" and the probability of AFF, and between VAT and the probability of metabolic disorders.

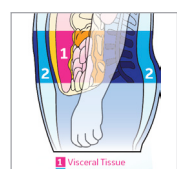

CoreScan with VAT and SAT Results
CoreScan estimates Visceral and Subcutaneous Adipose Tissue (VAT and SAT) mass, volume and area within the android region. Values can be displayed in user-defined statistical formats and trends.



Composer Reporting
Provides default style sheets, which can be edited using an intuitive WYSIWYG interface to quickly produce customized reports and templates.

Multi-User Database on a Secure Platform

Acquire and save images from multiple GE HealthCare densitometers to a common database.

Windows® 10 Compatibility

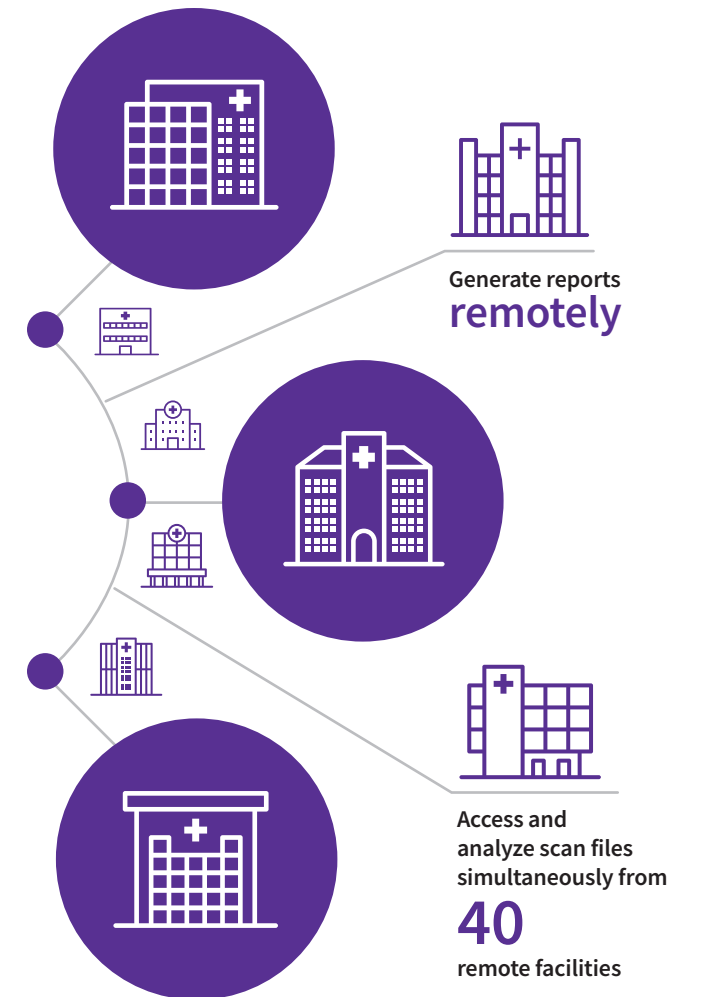

Advanced security features help protect your data.

Security Feature	Provided Benefit
IPv6 for DICOM and HL7	Communication protocol integrating IPsec for better security during data exchange
FIPS 140-2 Encryption	Federally compliant encryption standard that protects patient exam files using 256-bit encryption
Audit Trails	Logs information related to: <ul style="list-style-type: none"> • Software configuration and user access changes, destination IP addresses • Database events including authentication, patient modification/deletion • Events supported by the DICOM Audit Trail Profile
TLS for DICOM®	Provides security at the transport layer of a DICOM transaction by using encryption and node authentication. TLS is an updated, more secure, version of the SSL protocol.

Detailed assessment in just a few clicks

GE Healthcare Prodigy
 3030 Ohmeda Drive
 Madison, WI 53718
 Phone: 608 221-1551

Bone Densitometry Report: Monday, February 18, 2013

Referring Physician: Dr. Phlox

PATIENT:
 Name: #####
 Patient ID: ##### Birth Date: ##### Height: #####
 Sex: ##### Measured: ##### Weight: #####
 Indications: Low Calcium Intake Fractures: Treatments:

ASSESSMENT:
 The BMD measured at Femur Total Left is 0.928 g/cm² with a T-score of -0.6. Bone density is up to 10% below young normal. This patient is considered normal according to World Health Organization (WHO) criteria. With a Z-score of -0.1, this patient's BMD is within normal limits for their age and sex, even though bone loss may have occurred.

RECOMMENDATION:
 All patients should ensure an adequate intake of dietary calcium and vitamin D. The NOF recommends adults under age 50 need 1,000 mg of calcium and 400-800 IU of vitamin D daily. Adults 50 and over need 1,200 mg of calcium and 800-1,000 IU of vitamin D daily. Effective therapies for the prevention of osteoporosis include bisphosphonates (Fosamax and Actonel) and Evista. Hormone therapy may be an option based on review of risks and benefits of treatment.

FOLLOW-UP:
 People with diagnosed cases of osteoporosis or at high risk for fracture should have regular bone mineral density tests. For patients eligible for Medicare, routine testing is allowed once every 2 years. The testing frequency can be increased to one year for patients who have rapidly progressing disease, those who are receiving or discontinuing medical therapy to restore bone mass, or have additional risk factors.

Based on these results, a follow-up exam is recommended in ####

Fully customizable reports can be made as concise or as detailed as needed.

Treatment recommendations designated by the physician are automatically added and can include society guidelines.

GE Healthcare
 3030 Ohmeda Drive, Madison, WI 53718
 Phone: 608 221-1551

Patient: ##### Referring Physician: Dr. Phlox
 Birth Date: ##### Patient ID: #####
 Height: ##### Weight: ##### Measured: ##### (10.00)
 Sex: ##### Ethnicity: ##### Analyzed: ##### (15.00)

Region	BMD (g/cm ²)	Young-Adult T-score	Age-Matched Z-score	WHO Classification
AP Spine L1-L4	1.325	1.2	1.7	Normal
DualFemur				
Total Left	0.928	-0.6	-0.1	Normal
Total Right	0.970	-0.3	0.2	Normal
Total Mean	0.949	-0.5	0.1	Normal
Total Diff	0.042	0.3	0.3	N/A

OneScan performs spine and dual femur BMD measurements in a single protocol without repositioning.⁹ Results print in a one-page report.

General purpose business reporting tools help you manage your practice. Prodigy will automatically:

- Generate referring physician letters
- Analyze populations and trends
- Export data to tab-delimited text files for use in Microsoft Excel®

Robust Technology Foundation

Third generation DXA technology – with over 30 years of innovations

Patented Narrow Fan Beam Scan

Combining the features of pencil beams and wide fan beams, Narrow Fan Beam technology offers a shorter scan time with reduced magnification error (inherent to wide-angle fan beam scans).

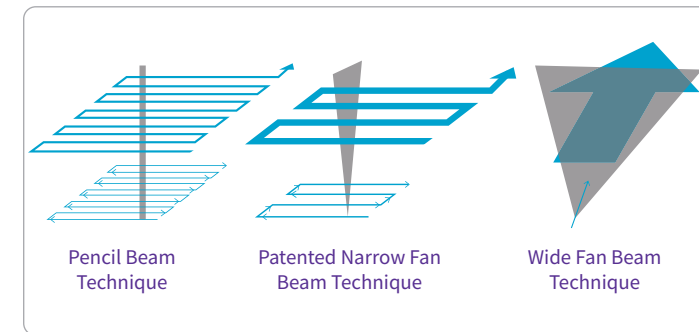

Low-Dose Photon Counting Technology

Dose-efficient photon counting detector technology more efficiently counts X-ray photons, lowering dosage to the patient.

Innovative SmartScan™

Our SmartScan technology reduces scan time and X-ray dosage by identifying bone regions after each transverse sweep and estimating where to begin scanning on the subsequent sweep.

K-edge Filter

An exceptional “K-edge filter” that creates a dual energy beam and absorbs the X-rays in the middle energy range and protects the patient against unnecessary exposure.

Multi-View Image Reconstruction (MVIR)

By performing multiple transverse sweeps across the site of interest, MVIR accurately determines bone-height above the tabletop, minimizes magnification errors and provides excellent precision and accuracy.

Low Scattered Radiation

Narrow-fan beam technology results in low scatter radiation in comparison to wide-angle fan beam systems.¹⁰

Performance comparison of DXA beam types

	Pencil Beam	Narrow Fan Beam	Wide Fan Beam
Scan time	Long	Short	Short
Bone height measured	No	Yes	No
Magnification effects	No	No	Yes
Off-center distortions	No	No	Yes
Scattered radiation	Lowest	Low	High

✓ Standard ● Optional ✕ Not Available

	Primo**	Pro	Advance
AP Spine	✓	✓	✓
Femur/Dual Femur	✓	✓	✓
Forearm/Non-seated Forearm	✓	✓	✓
Total Body BMD*	✓	✓	✓
FRAX® Fracture Risk Tool	✓	✓	✓
DVO Fracture Risk Tool ¹¹	✓	✓	✓
Multi-User Database (1-3)	✓	✓	✓
ScanCheck	✓	✓	✓
Practice Management	✓	✓	✓
Composer Report Tool	✓	✓	✓
OneScan	✓	✓	✓
OneVision	✓	✓	✓
Pediatric – AP Spine†	●	✓	✓
Pediatric – Femur†	●	✓	✓
Pediatric – TB (Birth to 20 YO)*	●	✓	✓
Total Body Composition*	●	✓	✓
DVA (Includes: LVA, APVA, Lateral BMD)†	●	●	✓
CoreScan™*	●	●	✓
Advanced Body Composition ^{12*}	✕	●	✓
Orthopedic Hip	✕	●	✓
Advanced Hip Assessment	✕	●	✓
Orthopedic Knee	✕	●	✓
Hand	✕	●	✓
Multi-User Database (Up to 40)	✕	●	✓
Atypical Femur Fracture	✕	●	●
Sarcopenia*	✕	●	●
Small Animal	✕	●	●
Quick View (10 second scan)	✕	✕	✓
Integrated TBS 3.1	●	●	●
DXAVision™*	✕	●	●
Sports Athletics Package*	✕	●	●
Advanced Analytics Full*	✕	●	●
Advanced Analytics Bone*	✕	●	●
Advanced Analytics Body Comp*	✕	●	●

Clinical Application

New V18 Applications

*Not available in Compact size.

**Prodigy Primo Compact model is not available in all countries – contact your GE HealthCare representative.

†Not available on Prodigy Primo Compact.

Specifications

Scanner dimensions:

Full-size bed:

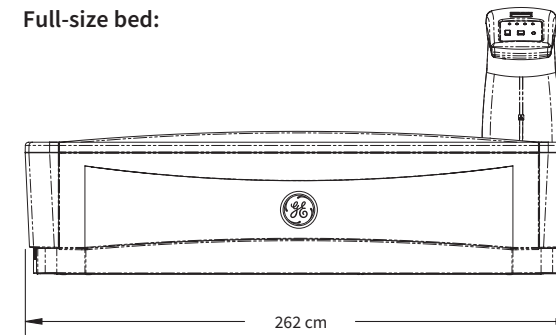

Compact bed:

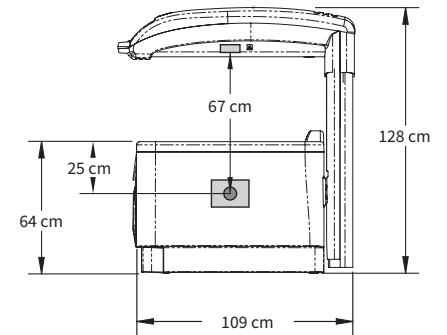
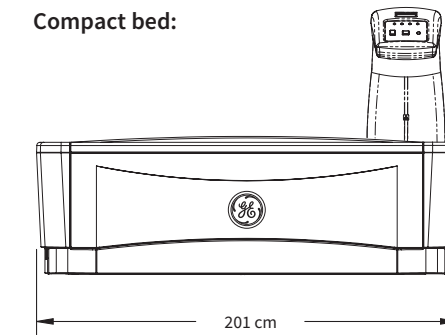

Minimum room dimensions¹³:

Full-size bed:

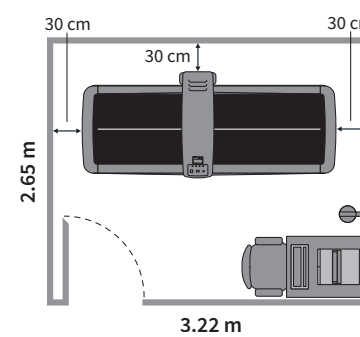

Compact bed:

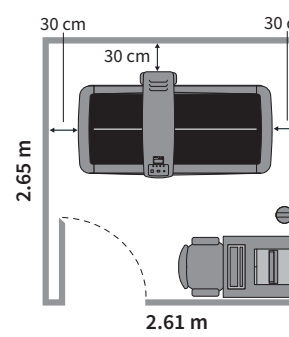

Computer specifications:

- Processor Intel® Core™ i3
- Operating System Windows® 10 2021 LTSC
- Memory RAM 8 GB
- Storage 1 TB NVMe SSD
- Optical Drive DVD-RW SATA
- Monitor 24" SVGA (min resolution 1920 x 1080 32-bit color)
- Archive Drive (optional) 1 TB USB
- Document viewing Adobe® Reader® DC
- Browser Microsoft Edge
- Connector RS-232 Serial Port
- Printer Windows®-compatible

Detector specifications:

- Detector LYSO X-ray counting detector

Environmental specifications:

- Power 200-240 VAC 50/60 Hz 10A dedicated circuit
- Consumption idling 40VA, scanning 450VA
- Distortion sinusoidal waveform, less than 5% THD
- Humidity 20%-80% non-condensing
- Room temperature 18°C-27°C
- Scanner heat output idling 150 BTU/hr, scanning 1500 BTU/hr
- Console heat output approx. 200 BTU/hr with 24" monitor
- Ventilation all cooling vents must remain unblocked
- Dust, fumes, debris install system in clean, ventilated area

Scanner table specifications:

- Scanner size (full-size bed) 262(W) x 109(D) x 128(H) cm
- Scanner size (compact bed) 201(W) x 109(D) x 128(H) cm
- Scanner weight (full-size bed) 272 kg
- Scanner weight (compact bed) 254 kg)
- Patient table top height 64 cm
- Drive system stepper motor with reinforced drive belts
- Active scan area (full-size bed) 196 cm x 60 cm
- Maximum patient weight supported 159 kg
- Active scan area (compact bed) 134 cm x 60 cm
- Start position indicator cross laser light (class II, <1 mW power)
- Pad washable patient mat
- Attenuation of patient support table <1.2 mm AL
- Communication cable 7.62 m serial
- Scanner leakage current meets IEC 60601-1 safety standard

Connectivity:

- Teledensitometry¹⁴
- DICOM® interface
- HL7 interface
- SQL Server

References:

1. Consult for market availability.
2. Requires purchase of AFF application and Corescan (for VAT and SAT) application.
3. Data on file with GE Healthcare, April 2019.
4. Requires DXAVision.™
5. Requires DXAVision™ or Sports Athletics Package.
6. Requires Advanced Analytics.
7. Customizable Threshold for AFF requires AFF Application.
8. Customizable Threshold for VAT requires CoreScan application.
9. S.M. Hunt et al, "Changing Bone Densitometers in Clinical Practice: Effect on Precision Error", Presented at the American Society for Bone and Mineral Research Annual Meeting, September 23-27, 2005, Nashville, TN, USA.
10. Data on file with GE Healthcare, January 2017.
11. German speaking countries only.
12. Bone-Lean-Tissue Color Coding, Metabolic Results (ICW, ECW, TBW), Resting Metabolic Rate, Composer Style Sheets – Body Sports Medicine Segmental, Body Patient Weight Loss.
13. A small room kit with isolation transformer may be required. Please refer to local regulations.
14. Additional hardware may be required for fax capabilities.

Products mentioned in the material may be subject to government regulations and may not be available in all countries. Shipment and effective sale can only occur after approval from the regulator. Please check with local GE HealthCare representative for details.

©2024 GE HealthCare. Prodigy, DXAVision, CoreScan and SmartScan are trademarks of GE HealthCare. DICOM is a trademark of National Electrical Manufacturers Association. FRAX is a registered trademark of the World Health Organization Collaborating Centre for Metabolic Bone Diseases, University of Sheffield, UK. Windows is a registered trademark of Microsoft Corporation. GE is a trademark of General Electric Company used under trademark license.

January 2024
JB00512XE



GE HealthCare